

ACCESSORIES

G-RAPID PLUS LOW FRICTION PASTE

**INSTALLATION
INSTRUCTIONS FOR
LET-LOK® FITTINGS**
38mm–50mm
1 1/4"–2"



1. Close the nut and ferrules on the tube with a hydraulic tool.
2. Open and release from the tool.
3. Apply the G-Rapid paste on areas A and B.
4. Tighten the nut on body 1/2 a turn with a wrench

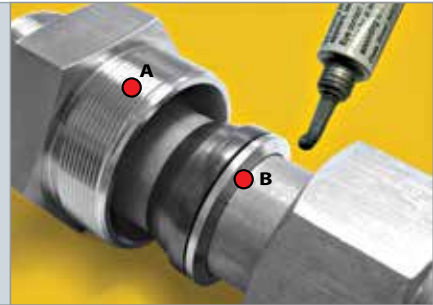

To order:
use part No. 3900753



GOLDEN GAUGE

SIZE:

GAUGE	
PART NO.	AVAILABLE ONLY IN
3900098	1/4" (6mm), 3/8", 1/2" (12mm)

HIGH
SAFETY
SIDE

HIGH SAFETY

In applications where severe conditions and high pressure exist, we recommend the following installation procedures:

1. Check that the nut is finger tight.
2. Insert the tube (up to the shoulder).
3. Rotate the nut with a wrench until the tube does not rotate freely.
4. Mark position of the nut.
5. Rotate the nut 1-1/4 turns.

This method ensures that even if the tube O.D. is at the minimum tolerance, the ferrules will be in contact with the tube for the full 1-1/4 rotation.

ADDITIONAL SIZES:

GOLDEN GAUGE	
PART NO.	LET-LOK® SIZE
3901508	Golden Gauge 1/16"
3901509	Golden Gauge 1/8"–2–3 mm
3901510	Golden Gauge 3/16"– 4 mm
3901513	Golden Gauge 5/16"– 8 mm
3901511	Golden Gauge 10 mm
3901247	Golden Gauge 5/8"–14–15–16 mm
3901246	Golden Gauge 3/4"–18 mm
3901512	Golden Gauge 7/8"–20–22 mm
3901245	Golden Gauge 1"–25 mm

Dimensions are for reference only, and are subject to change without notice.

HAM-LET PREASSEMBLY TOOL

In constrained installation areas, LET-LOK® fittings can be assembled with the preassembly tool and a second step on the system.

PART NO.	LET-LOK® SIZE
3902419	PREASSEMBLY TOOL 1/8
3901658	PREASSEMBLY TOOL 1/4
3901659	PREASSEMBLY TOOL 3/8
3901660	PREASSEMBLY TOOL 1/2
3902719	PREASSEMBLY TOOL 5/8
3902402	PREASSEMBLY TOOL 6MM
3902420	PREASSEMBLY TOOL 8MM
3902421	PREASSEMBLY TOOL 10MM
3902422	PREASSEMBLY TOOL 12MM
3902720	PREASSEMBLY TOOL 14MM
3902721	PREASSEMBLY TOOL 15MM
3902538	PREASSEMBLY TOOL 16MM

Instruction for using "Preassembly Tool" 6mm-16mm, 1/4"-5/8"

1. Assemble HAM-LET ferrules and nut on the Preassembly Tool, tighten the nut to finger tight position.
2. Insert the tube through the nut and ferrules until the tube touches the bottom (shoulder).
3. From the finger tight position, rotate the nut 1-1/4 turns (450°).
4. Release the nut from the Preassembly Tool; pull out the tube with the ferrules swaged into the tube.
5. Insert tube with swaged ferrules into the fitting body.
6. Tighten the nut to the finger tight position (mark the place).
7. To assemble on the fitting, use a wrench to tighten the nut to the original position. An increase of torque will be felt, from this point turn the wrench slightly.

Tightening to the original position depends on the tube size.

A large tube size will need more tightening than a small size, and the wall thickness has some effect on the tightening.

Note:

1. When using the Preassembly Tool, make sure the tool is free of damage and is clean prior to use.
2. Usage of the Preassembly Tool is limited, after permanent use please send tool to HAM-LET for evaluation.
3. Soft tubing and tubing at the maximum diameter tolerance can cause the tube to stick to Preassembly Tool.
In order to remove the stuck tube, please rock the tube back and forth until the tube gets released from the tool.



Instruction for using "Preassembly Tool" 1/8"-3/16", 2mm-4mm

1. Assemble HAM-LET ferrules and nut on the Preassembly Tool, tighten the nut to the finger tight position.
2. Insert the tube through the nut and ferrules until the tube touches the bottom (shoulder).
3. From the finger tight position, rotate the nut 3/4 of a turn (270°).
4. Release the nut from the Preassembly Tool; pull out the tube with the ferrules swaged into the tube.
5. Insert tube with swaged ferrules into the fitting body.
6. Tighten the nut to the finger tight position (mark the place).
7. To assemble on the fitting, use a wrench to tighten the nut to the original position. An increase of torque will be felt, from this point turn the wrench slightly.

Tightening to the original position depends on tube size.

A large tube size will need more tightening than a small size, and the wall thickness has some effect on the tightening.

ACCESSORIES



STAINLESS STEEL TUBE CUTTER

Ordering Information	Capacity	
	inch	mm
Tube Cutter	3/16-1	5-25
Replacement Wheel	3/16-1	5-25



REAMERS, DEBURRING TOOLS

Ordering Information	Capacity
In.Out.Reamer 1/4"-1 1/4"	1/4" (5mm) through 1 1/4" (36mm)
In.Out.Reamer 1/2"-2"	1/2" (12mm) through 2" (54mm)



LEVER TUBE BENDERS

Ordering Information	Capacity	
	Tube Size	Bend Radius
Lever Bender 3/16	3/16"	5/8"
Lever Bender 1/4	1/4"	5/8"
Lever Bender 5/16	5/16"	15/16"
Lever Bender 3/8	3/8"	15/16"
Lever Bender 1/2	1/2"	1 1/2"
Lever Bender 6	6mm	16mm
Lever Bender 8	8mm	24mm
Lever Bender 10	10mm	24mm
Lever Bender 12	12mm	38mm



HYDRAULIC PRE-ASSEMBLY TOOL

Ordering Information	Description	
HPAT- Large	Full large size tool - 1", 1 1/4", 1 1/2"	
HPAH - 1"	1"	Pre Assembly Head
HPAH - 1 1/4"	1 1/4"	
HPAH - 1 1/2"	1 1/2"	



TUBE HOLDERS

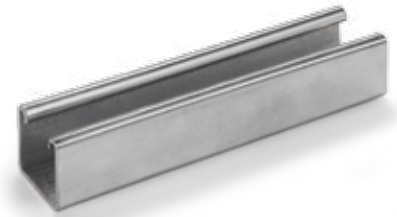
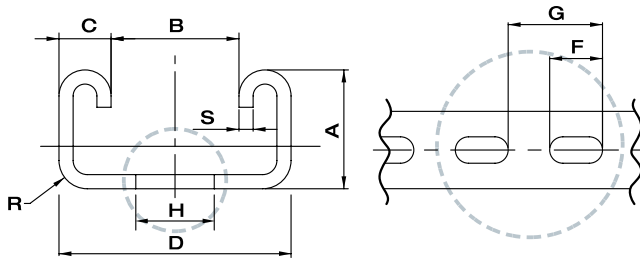

PERFORATED STAINLESS STEEL TUBE HOLDER SUPPORT

HL / PN	A, mm	B, mm	C, mm	D, mm	L, m	S, mm	R, mm	F, mm	G, mm	H, mm
P-L-G	41.0	22.6	9.2	41.0	6.0	2.5	5.0	28.0	50.0	14.0
P-S-G	21.0	22.6	9.2	41.0	6.0	2.5	5.0	28.0	50.0	14.0
P-L-Z	41.0	22.6	9.2	41.0	6.0	2.5	5.0	28.0	50.0	14.0
P-S-Z	21.0	22.6	9.2	41.0	6.0	2.5	5.0	28.0	50.0	14.0

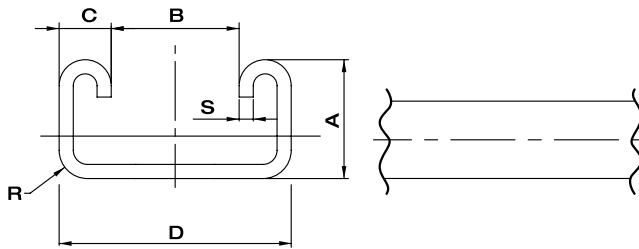

BLANK STAINLESS STEEL TUBE HOLDER SUPPORT

HL / PN	A, mm	B, mm	C, mm	D, mm	L, m	S, mm	R, mm
B-L-G	41.0	22.6	9.2	41.0	6.0	2.5	5.0
B-S-G	21.0	22.6	9.2	41.0	6.0	2.5	5.0
B-L-Z	41.0	22.6	9.2	41.0	6.0	2.5	5.0
B-S-Z	21.0	22.6	9.2	41.0	6.0	2.5	5.0

ORDERING INFORMATION

Perforation

P = Perforated
B = Blank

Size

S = Small
L = Large

Finish Type

Z = Zink Coating Yellow
G = Hot dip galvanized

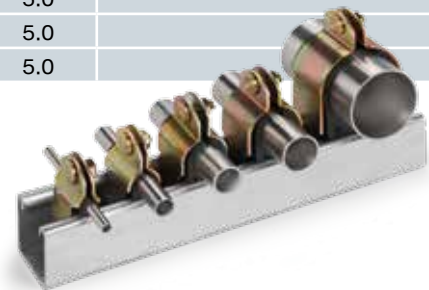

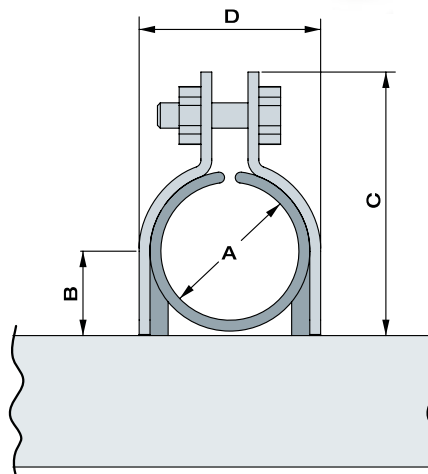

CLAMPED TUBE HOLDERS

HL / PN	A, mm	B, mm	C, mm	D, mm
CTH-1/4	1/4	5.7	29.2	18.2
CTH-3/8	3/8	7.3	32.2	23.0
CTH-1/2	1/2	7.8	36.6	23.7
CTH-5/8	5/8	22.6	41.7	25.0
CTH-3/4	3/4	13.8	48.3	32.7
CTH-7/8	7/8	22.6	51.2	34.0
CTH-1	1	16.8	53.8	40.8
CTH-1 1/8	1-1/8	22.6	59.4	40.9
CTH-1 5/8	1-5/8	22.6	71.8	58.3
CTH- 2	2	30.4	82.0	64.1

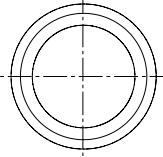

STOP COLLAR

LET-LOK®			D	Assembly Instructions - Stop Collar	
inch	inch	mm			
1/4	.69	17.5	1. Remove the nut and ferrules from the fitting. 2. Insert the stop collar. 3. Assemble the nut and ferrules until finger tight. 4. Make up the fitting until the stop collar no longer rotates (feel with finger). At this stage it is guaranteed that the fitting is assembled correctly.		
3/8	.84	20.6			
1/2	1.10	27.0			
3/4	1.31	33.3			
1	1.68	42.7			

ORDERING INFORMATION FOR ASSEMBLED STOP COLLAR (WITH FITTING)

768L	SS	1/4	1/4	SC
Fitting Type	SS = Stainless Steel 316 B = Brass M = Alloy 400 HC = Alloy C-276	Tube O.D. The O.D. size is always the first to be described	X	1/4 NPT Stop Collar
Male LET-LOK® Connector Male End Connection	Fitting Material			

HOW TO ORDER STOP COLLAR ONLY

STOP COLLAR	1/4
Stop Collar	Tube O.D. The O.D. size is always the first to be described

Dimensions are for reference only, and are subject to change without notice.

Let-Lok® tube Fittings, Rev.02, January